

PRODUCT SPECIFICATIONS

Elkay Lustertone™ Classic Stainless Steel, 23-1/2" x 18-1/4" x 4-7/8", Single Bowl Undermount ADA Sink w/Perfect Drain. Sink is manufactured from 18 gauge 304 Stainless Steel with a Lustertone finish, Rear Center drain placement, and Bottom only pads.

Installation Type:	Undermount
Material:	304 Stainless Steel
Special Features:	Perfect Drain
Finish:	Lustertone
Gauge:	18
Sound Deadening:	Bottom only pads
Number of Bowls:	1
Sink Dimensions:	23-1/2" x 18-1/4" x 4-7/8"
Bowl 1 Dimensions:	21" x 15-3/4" x 4-7/8"
Drain Size:	3-3/8" (86mm)
Drain Location:	Rear Center
Minimum Cabinet Size:	27"
Mounting Hardware:	Undermount brackets sold separately
Template Included:	Yes
Cutout Template #:	1000001400

Template is available for download at [elkay.com](#)

Perfect Drain: Seamlessly welded stainless steel collar eliminates the gap between a traditional drain and the sink for a sanitary and gap free installation. An InSinkErator® garbage disposer can be installed on either sink bowl for user convenience.

U.S. Patent Nos 9,057,185 and 9,783,968.

in sink erator[®]

Elkay[®] Perfect Drain™ sinks are designed and approved for compatible disposers manufactured by InSinkErator[®] utilizing the Quick Lock[®] mounting configuration. Use of non-approved disposers may void Elkay warranty.

InSinkErator, Quick Lock and the mounting collar configuration are trademarks of Emerson Electric Co.



Included with Product: One LKPD1 Perfect Drain and strainer.

AMERICAN PRIDE. A LIFETIME TRADITION. Like your family, the Elkay family has values and traditions that endure. For almost a century, Elkay has been a family-owned and operated company, providing thousands of jobs that support our families and communities.



Product Compliance: ADA & ICC A117.1
ASME A112.19.3/CSA B45.4
BUY AMERICAN ACT
Accessory: ASME A112.18.2/CSA B125.2



Sinks are listed by IAPMO[®] as meeting the applicable requirements of the Uniform Plumbing Code[®], International Plumbing Code[®], and National Plumbing Code of Canada.



Complies with ADA & ICC A117.1 accessibility requirements when installed according to the requirements outlined in these standards.

[Clean and Care Manual \(PDF\)](#)
[Installation Instructions \(PDF\) - 1000002045](#)
[Installation Instructions \(PDF\) - 74180289 Disposer](#)
[Installation Instructions \(PDF\) - 74180340-USA Drain](#)
[Limited Lifetime Warranty \(PDF\)](#)

Similar models are available with: additional ADA depths

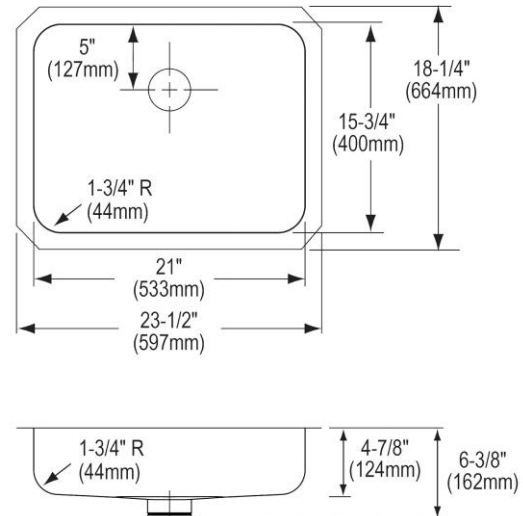

PART: _____ QTY: _____

PROJECT: _____

CONTACT: _____

DATE: _____

NOTES: _____

APPROVAL: _____

In keeping with our policy of continuing product improvement, Elkay reserves the right to change product specifications without notice. Please visit [elkay.com](#) for the most current version of Elkay product specification sheets. This specification describes an Elkay product with design, quality, and functional benefits to the user. When making a comparison of other producers' offerings, be certain these features are not overlooked.

Installation Profile:

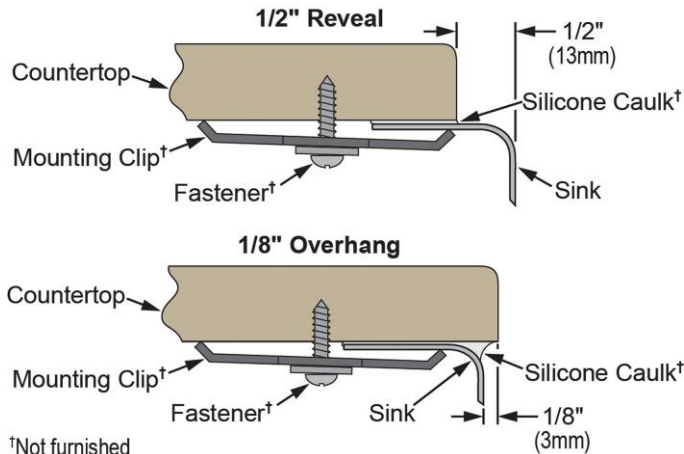

†Not furnished

Designed to affix to the underside of any solid surface countertop.

OPTIONAL ACCESSORIES

Bottom Grid:	LKWOBG2115SS
Cutting Board:	CB1516*
Drain:	LKPDVR18B, LKPDAD18B, LKDS99
Faucet:	LKGT1041, LKGT2041
Hardware:	LKUCLIP8
Rinsing Basket:	LKWERBSS
Soap Dispenser:	LKGT1054
* 1/2" sink reveal required for proper fit.	

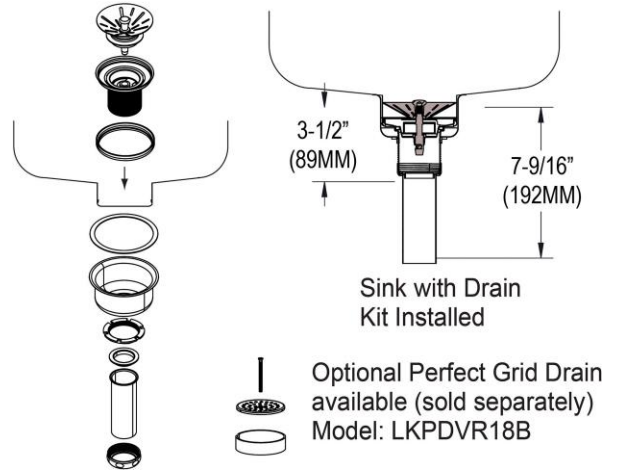

In keeping with our policy of continuing product improvement, Elkay reserves the right to change product specifications without notice. Please visit elkay.com for the most current version of Elkay product specification sheets. This specification describes an Elkay product with design, quality, and functional benefits to the user. When making a comparison of other producers' offerings, be certain these features are not overlooked.