

PRODUCT SPECIFICATIONS

Lustertone® Classic Stainless Steel 14-1/2" x 11-3/4" x 7" Single Bowl Undermount Bar Sink. Sink is manufactured from 18 gauge 304 Stainless Steel with a Lustrous Satin finish, Center drain placement, and Sides and Bottom pads.

Installation Type:	Undermount
Material:	304 Stainless Steel
Finish:	Lustrous Satin
Gauge:	18
Sound Deadening:	Sides and Bottom pads
Number of Bowls:	1
Sink Dimensions:	14-1/2" x 11-3/4" x 7"
Bowl 1 Dimensions:	12" x 9-1/4" x 7"
Drain Size:	2" (51mm)
Drain Location:	Center
Minimum Cabinet Size:	18"
Mounting Hardware:	Undermount brackets sold separately
Template Included:	Yes
Cutout Template #:	1000001421

Template is available for download at elkay.com. CAD software will be required to open the template.

Installation Profile:

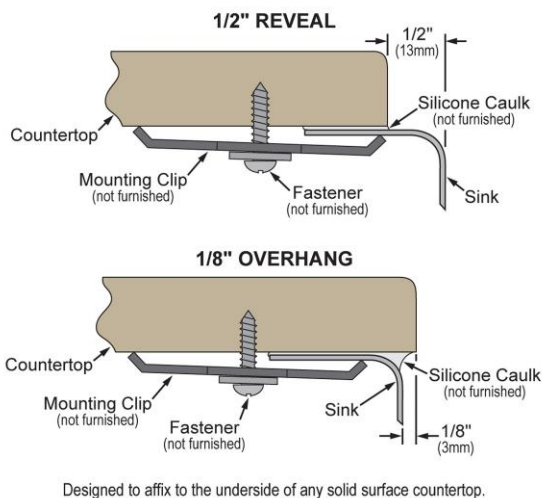

A Century of Tradition and Quality. For more than 100 years, Elkay has been making innovative products and providing exceptional customer care. We take pride in offering plumbing products that make life easier, inspire change and leave the world a better place.



Product Compliance: ASME A112.19.3/CSA B45.4





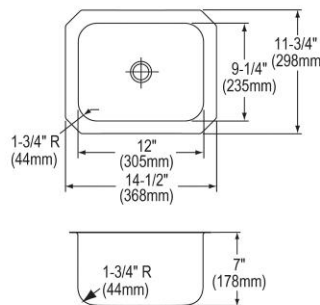

Sinks are listed by IAPMO® as meeting the applicable requirements of the Uniform Plumbing Code®, International Plumbing Code®, and National Plumbing Code of Canada.

[Clean and Care Manual \(PDF\)](#)
[Installation Instructions \(PDF\) - 1000005239](#)
[Warranty \(PDF\)](#)



PART: _____ QTY: _____
 PROJECT: _____
 CONTACT: _____
 DATE: _____
 NOTES: _____
 APPROVAL: _____

In keeping with our policy of continuing product improvement, Elkay reserves the right to change product specifications without notice. Please visit elkay.com for the most current version of Elkay product specification sheets. This specification describes an Elkay product with design, quality, and functional benefits to the user. When making a comparison of other producers' offerings, be certain these features are not overlooked. Latest version of the spec sheet available: https://www.elkayfiles.com/spec-sheets/ELUH129_spec.pdf

Optional Accessories		
LKWBG1209SS	Elkay Stainless Steel 11" x 8" x 1" Bottom Grid Spec Sheet (PDF)	
CB912	Hardwood 12-7/8" x 10-1/8" x 1" Cutting Board Spec Sheet (PDF)	
LK36	Drain Fitting 2" Nickel Plated Brass Body with Deep Stainless Steel Strainer Basket Spec Sheet (PDF)	
LKGT1042	Elkay Gourmet Single Hole Bar Faucet Pull-out Spray and Lever Handle Spec Sheet (PDF)	
LKWRB1209SS	Elkay Stainless Steel 8" x 11" x 7" Rinsing Basket Spec Sheet (PDF)	

In keeping with our policy of continuing product improvement, Elkay reserves the right to change product specifications without notice. Please visit elkay.com for the most current version of Elkay product specification sheets. This specification describes an Elkay product with design, quality, and functional benefits to the user. When making a comparison of other producers' offerings, be certain these features are not overlooked. Latest version of the spec sheet available: https://www.elkayfiles.com/spec-sheets/ELUH129_spec.pdf